

ELINTARVIKEALAN KUVAKORTIT



**AMMATTISANASTO
TYÖHÖNPEREHDYTTÄJÄN
APUVÄLINEEKSI**



**Euroopan unionin
osarahoittama**



Tähän korttipakkaan on koottu elintarvikealan sanastoa helpottamaan työnopastusta.

Kortit on tehty SUJUVA – sujuvasti maahanmuuttajat töihin elintarvikealalle - hankkeessa.

Hanke on Euroopan unionin osarahoittama ja sen toteutusaika on 1.11.2022 – 31.10.2025. Kuvat on luotu tekoälyn avulla.

Hämeen ammatti-instituutti Oy



EI KORUJA



EI MEIKKIÄ

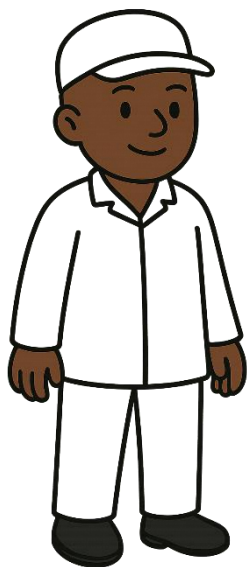

TYÖVAATETUS



PUKUKAAPPI



VESIHANA



NESTESAIPPUA

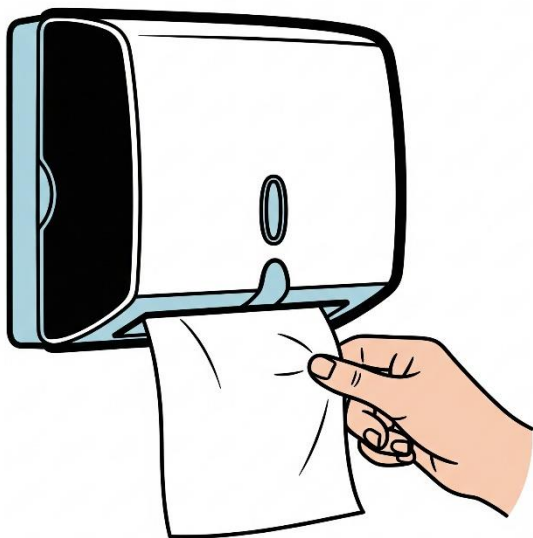

KÄSIPYYHEPAPERI



KENKÄPESURI

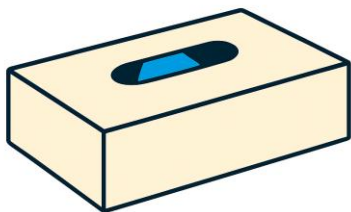
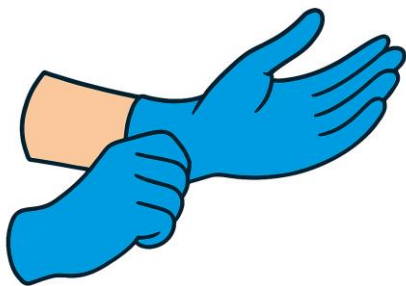

KERTAKÄYTTÖKÄSINEET



VIILTOSUOJAKÄSINEET



KUULOSUOJAIMET

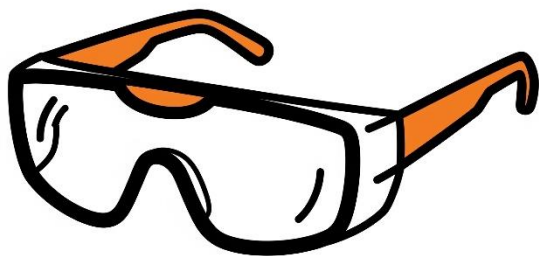

SUOJALASIT



HUOMIOLIIVI



HENGITYSSUOJAIN



ESILIINA

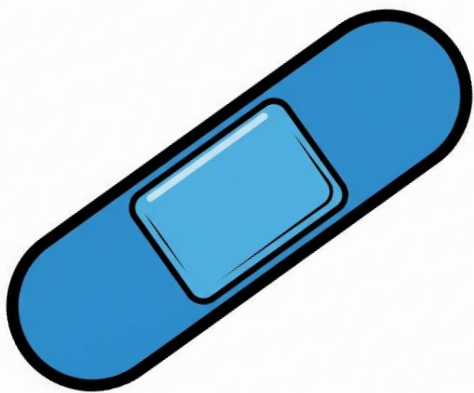

LAASTARI



HÄTÄSUIHKU



HÄTÄNUMERO 112-SOVELLUS



ENSIAPUKAAPPI



SILMÄNHUUHTELUPULLOT



SAMMUTUSPEITE



VAAHTOSAMMUTIN



HÄTÄPOISTUMISTIE



KOKOONTUMISPAIKKA



**PIDÄ KIINNI KAITEESTA
PORTAISSA**



METALLINPALJASTIN



TRUKKI

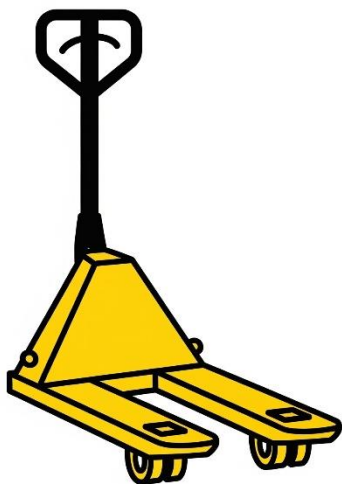

PUMPPUKÄRRYT

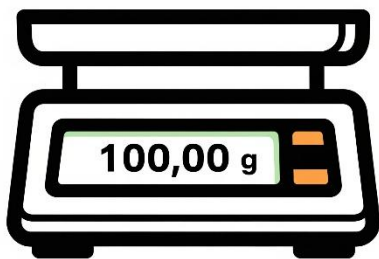

VAAKA

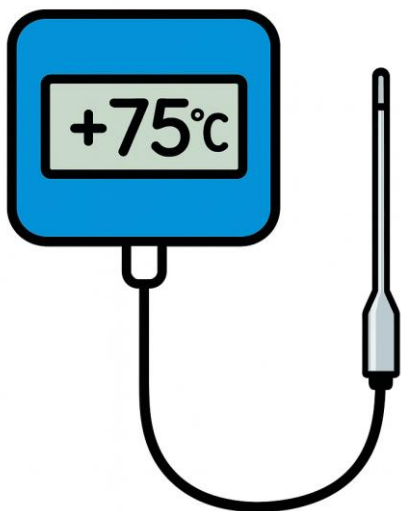

LÄMPÖMITTARI

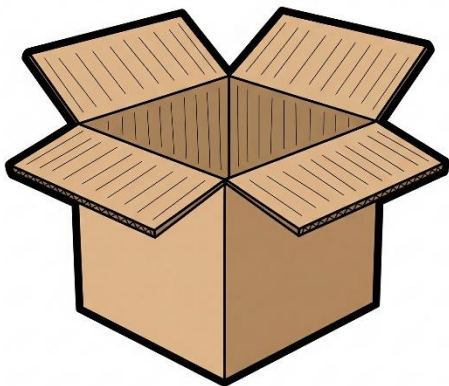

PAHVILAATIKKO

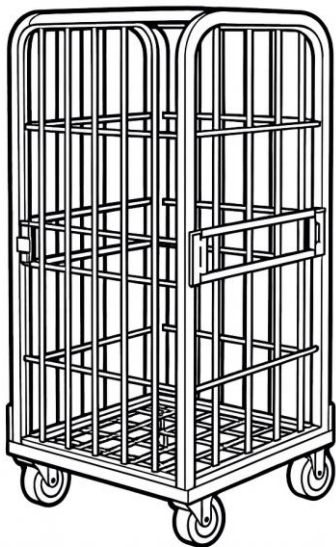

RULLAKKO

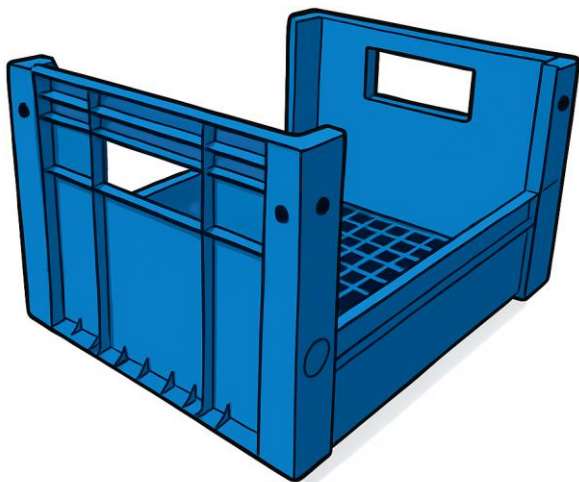

MAITOLAATIKKO

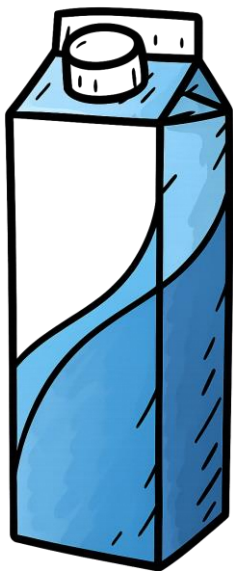

MAITOTÖLKKI



KUORMALAVA (FIN)

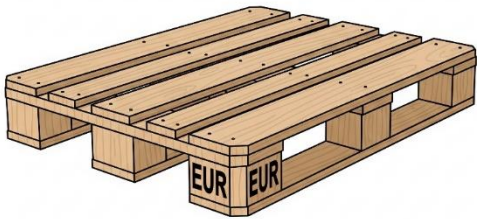

KUORMALAVA (EUR)

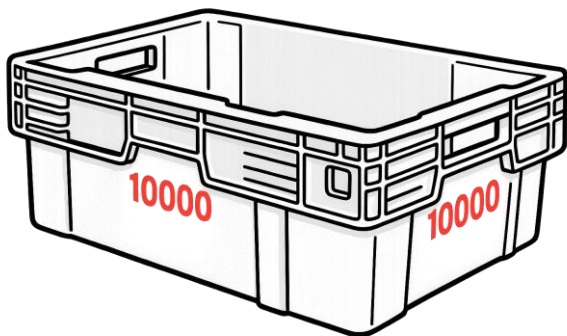

LIHALAATIKKO
POOLILAATIKKO

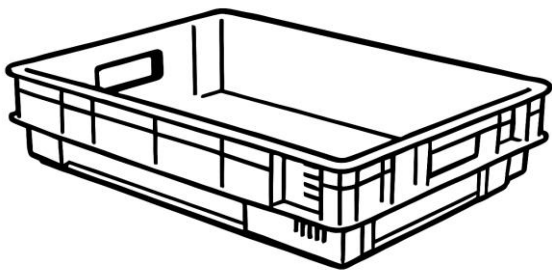

EINESLAATIKKO

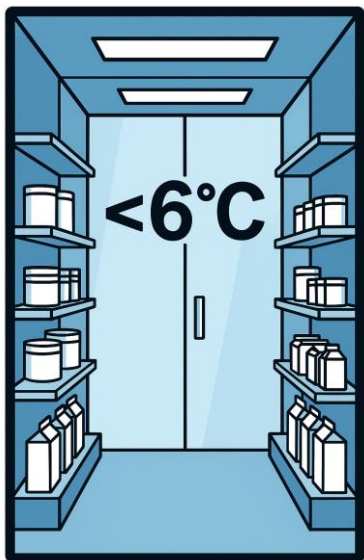

KYLMÄHUONE

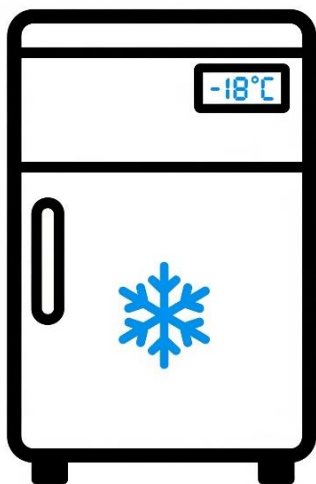

PAKASTIN



VESILETKU



**KEMIKAALIN
VAROITUSMERKKI**

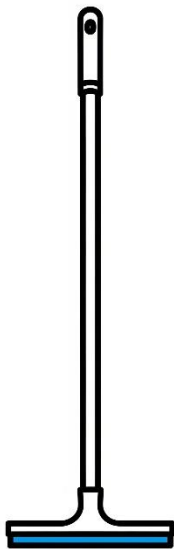

LATTIALASTA

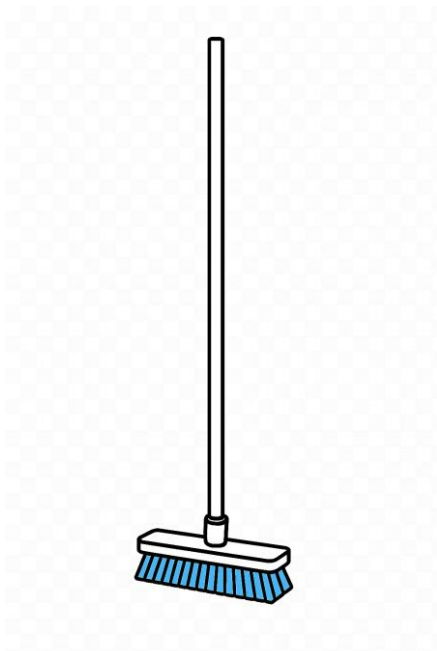

LATTIAHARJA

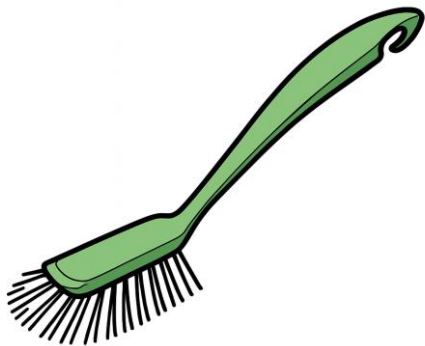

TISKIHARJA



PESUAINE

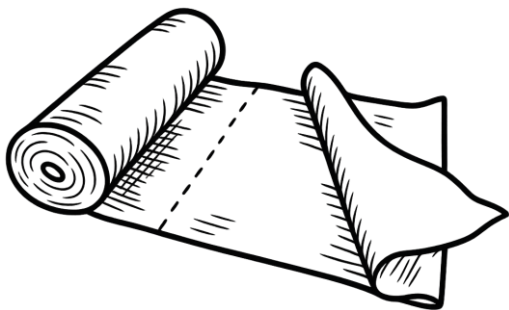

PUHDISTUSLIINA



SUIHKEPULLO



MUOVIÄMPÄRI

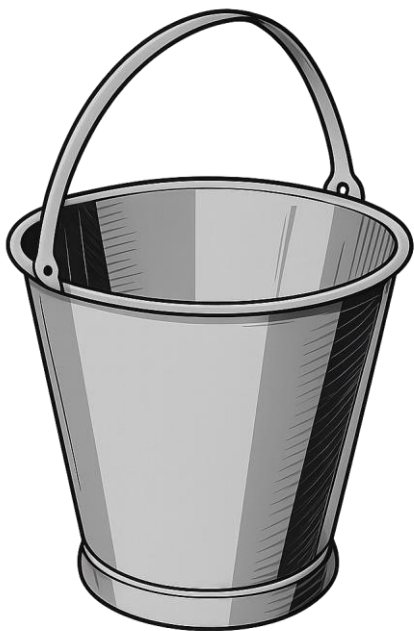

TERÄSÄMPÄRI



ETIKETTI



PÄIVÄYSLEIMA



PAKKAUS



PULLO



JUOMATÖLKKI

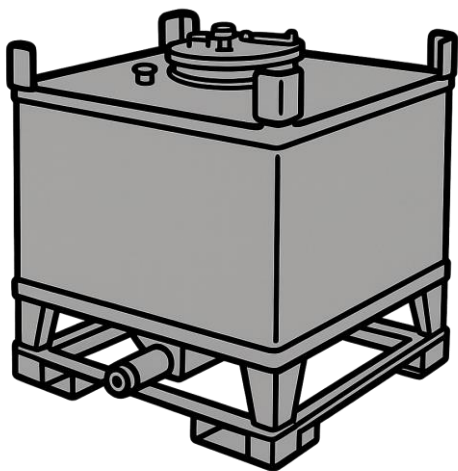

KONTTI

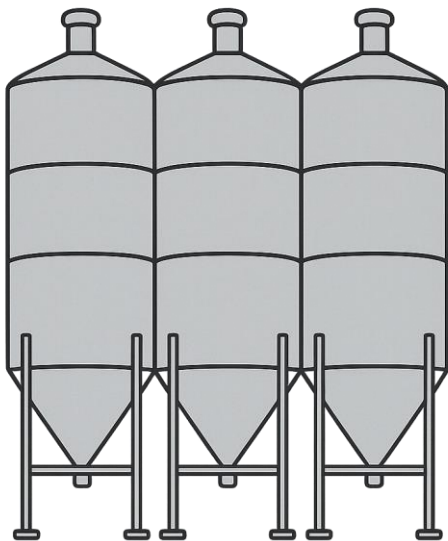

SILO

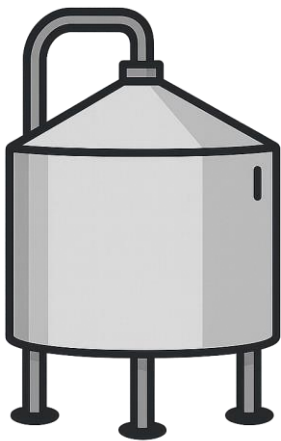

SÄILIÖ



ALLASVAUNU
“MOLLA”



TERÄSVAUNU



JÄTESÄKKI



ROSKAPUSSI

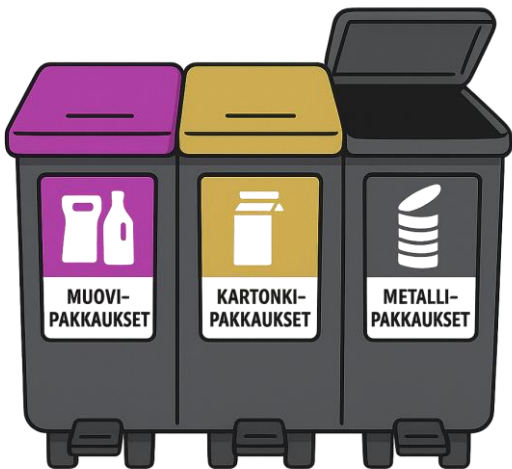

ROSKA-ASTIA



SEKAJÄTE



BIOJÄTE



LASI



METALLI



MUOVI



PAPERI



PAHVI



Gluteeni



Äyriäiset



Kalat



Maito



Munat



Pähkinät



Soijapavut



Nilviäiset



Pähkinät

ALLERGEENEJÄ



Sinappi



Selleri



Lupiini



Seesamin-
siemenet



Rikkidioksidia
sisältävät
kuivatut
hedelmät

ALLERGEENEJÄ

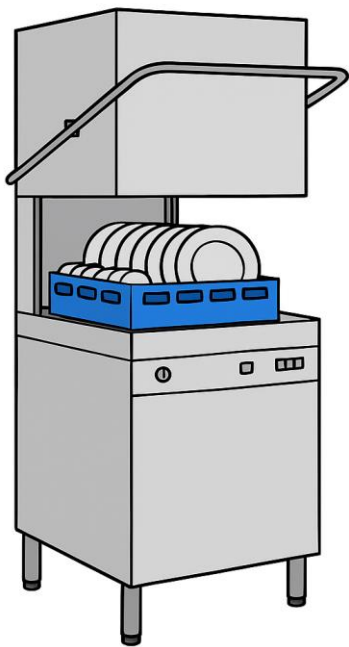

ASTIANPESUKONE

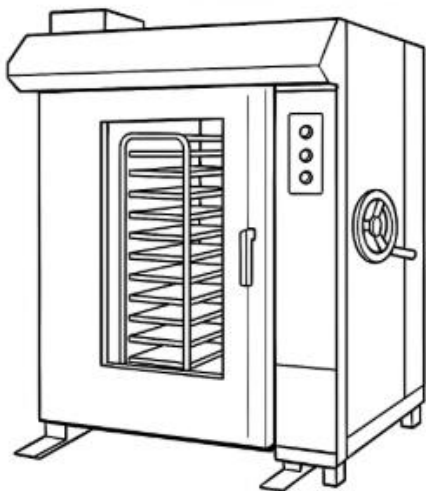

UUNI



TAIKINAKONE

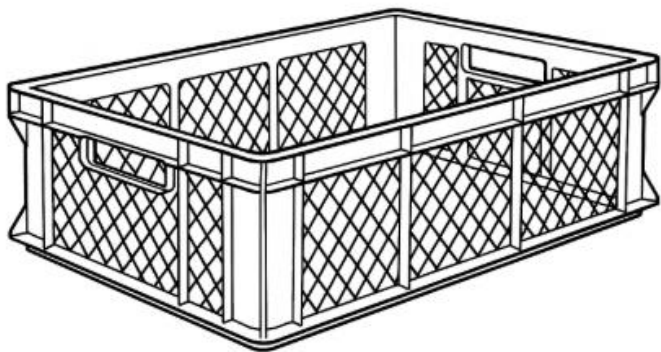

LEIPOMOLAATIKKO

